

No. 6941KP

Swing clamp, top-flange-mounting

Double-acting,
max. operating pressure 100 bar,
min. operating pressure 20 bar.

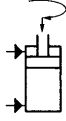

Order no.	Article no.	Clamping force at 100 bar Sp* [kN]	Clamping stroke M [mm]	Total stroke N [mm]	Vol. Sp [cm ³]	Vol. Lo [cm ³]	eff. piston area Sp [cm ²]	eff. piston area Lo [cm ²]	min. permitted clamping time* [s]	Q max.* [l/min]	Piston mass moment of inertia JK [kgm ²]	Weight [g]
556960	6941KP-03-21	3,3	5,4	10,7	4,8	6,4	4,1	6,2	0,44	0,65	0,000006146	642
556961	6941KP-03-22	3,3	5,4	10,7	4,8	6,4	4,1	6,2	0,44	0,65	0,000006146	642
556962	6941KP-04-21	4,5	5,4	13,0	7,3	10,6	5,5	8,0	0,36	1,2	0,000011573	830
556963	6941KP-04-22	4,5	5,4	13,0	7,3	10,6	5,5	8,0	0,36	1,2	0,000011573	830
556964	6941KP-05-21	5,5	6,2	13,7	9,3	13,8	6,8	11,9	0,34	1,6	0,000029315	1284
556965	6941KP-05-22	5,5	6,2	13,7	9,3	13,8	6,8	11,9	0,34	1,6	0,000029315	1284
556966	6941KP-09-21	9,4	5,5	15,4	16,9	24,5	11,0	16,0	0,34	2,9	0,000055671	1778
556967	6941KP-09-22	9,4	5,5	15,4	16,9	24,5	11,0	16,0	0,34	2,9	0,000055671	1778
556968	6941KP-11-21	11,0	7,5	16,5	21,8	35,0	13,2	21,3	0,32	4,0	0,000137759	2805
556969	6941KP-11-22	11,0	7,5	16,5	21,8	35,0	13,2	21,3	0,32	4,0	0,000137759	2805

Cl = clamping, Uncl = unclamp

* Specifications with clamping arm, standard (6951)

Design:

Cylinder barrel made of steel, hardened and burnished. Piston rod nitrided. Piston rod with internal thread. O-ring for flange seal. Wiper at the piston rod. Clamp arm not supplied as standard. Oil supply via threaded connection or oil channel in the fixture body.

Application:

The swivel clamp is used in fixtures in which the workpiece must be freely accessible and inserted from above. Even workpieces with difficult shapes can be clamped using special clamp arms (available on request).

Features:

The swing motion is executed via three ball guides, thereby increasing positioning accuracy, repeat accuracy and service life.

Note:

The piston stroke is executed with spheres, so volume flow Q max. must be complied with. Clamping arm length and clamping arm weight must be strictly observed. No force may be applied to the piston when mounting accessories to it. To equalise height differences on the workpiece, the vertical clamping path must be 50% of the clamping stroke. When placing into operation, ensure that all air is bled from the system. To throttle the oil feed, the throttle/check valve no. 6916-12-01 for G1/8 can optionally be used. Other swivel angles are available on request.

Formula to determine the total mass moment of inertia and the volume flow:

total mass moment of inertia Jges. [kgm²]
Clamp arm mass moment of inertia JH [kgm²]
Piston mass moment of inertia JK [kgm²]
Clamp arm load mH [kg]
Centre of gravity distance Ls [m]
Jges. = JK + JH + mH x Ls² [kgm²]

Volume flow Qmax. [cm³/s]
Volume clamp Vol.sp [cm³]
Minimum permitted clamp time tmin. [s]
Qmax. = Vol.sp / tmin. [cm³/s]

Suitable clamp arms are 6951-XX.

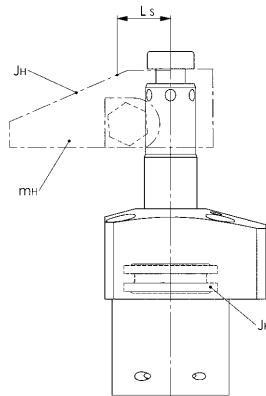

Code of types:

Type 21 = double acting, right swinging
 Type 22 = double acting, left swinging

Positioning:

Positioning hole for clamp arm:

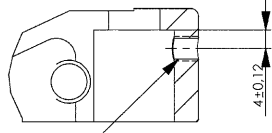

threaded stud
 Size 03 - 09

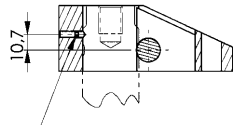

threaded stud
 Size 11

Swing directions:

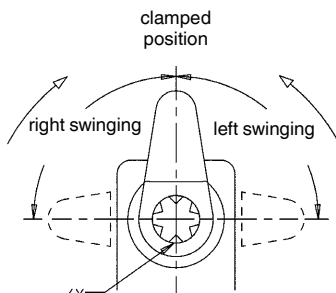

Positioning hole for clamp arm (6x60°)

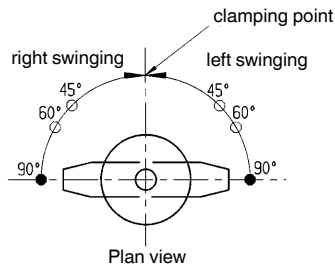

● = Standard type
 ○ = Special type

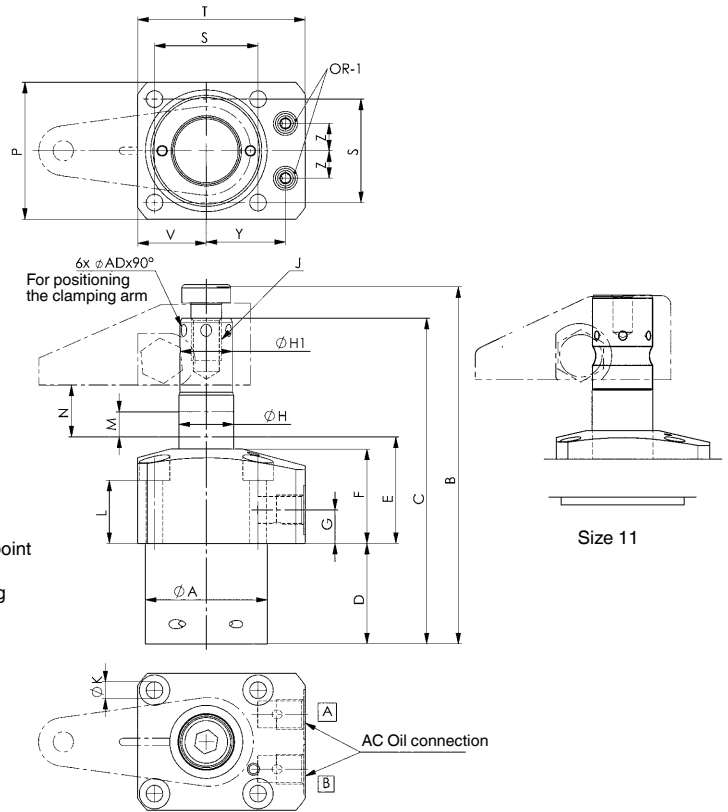

A = clamp
 B = unclamp

Dimensions:

Order no.	Article no.	dia. A	B	C	D	E	F	G	dia. H	dia. H1	J x depth	dia. K	L	M	N	P	S	T	V	Y	Z	AC	∅AD	OR-1 O-ring Order No.
556960	6941KP-03-21	36	104,5	95,2	28	38,5	29,5	11,5	16	15,88	M10 x 14	4,5	20,5	5,4	10,7	40	31,4	52,5	22,0	23,5	8,5	G1/8	4,8	457499
556961	6941KP-03-22	36	104,5	95,2	28	38,5	29,5	11,5	16	15,88	M10 x 14	4,5	20,5	5,4	10,7	40	31,4	52,5	22,0	23,5	8,5	G1/8	4,8	457499
556962	6941KP-04-21	40	117,5	107,0	33	39,0	31,0	11,0	18	-	M10 x 14	5,5	20,7	5,4	13,0	45	34,0	55,0	22,5	26,0	9,0	G1/8	4,8	457499
556963	6941KP-04-22	40	117,5	107,0	33	39,0	31,0	11,0	18	-	M10 x 14	5,5	20,7	5,4	13,0	45	34,0	55,0	22,5	26,0	9,0	G1/8	4,8	457499
556964	6941KP-05-21	48	130,0	117,0	33	45,0	36,5	13,0	24	22,23	M12 x 14	5,5	26,5	5,3	13,7	51	40,0	61,0	25,5	30,0	11,0	G1/8	4,8	457499
556965	6941KP-05-22	48	130,0	117,0	33	45,0	36,5	13,0	24	22,23	M12 x 14	5,5	26,5	5,3	13,7	51	40,0	61,0	25,5	30,0	11,0	G1/8	4,8	457499
556966	6941KP-09-21	55	149,4	134,4	39,5	49,0	36,0	12,0	25	-	M12 x 14	6,6	24,2	5,5	15,4	60	47,0	69,0	30,0	33,5	12,0	G1/8	4,8	457499
556967	6941KP-09-22	55	149,4	134,4	39,5	49,0	36,0	12,0	25	-	M12 x 14	6,6	24,2	5,5	15,4	60	47,0	69,0	30,0	33,5	12,0	G1/8	4,8	457499
556968	6941KP-11-21	65	155,0	155,0	44,5	49,3	39,0	13,0	32	31,79	M12 x 14	6,6	25,6	5,5	16,5	70	55,0	81,0	35,0	39,5	15,0	G1/4	4,8	493478
556969	6941KP-11-22	65	155,0	155,0	44,5	49,3	39,0	13,0	32	31,79	M12 x 14	6,6	25,6	5,5	16,5	70	55,0	81,0	35,0	39,5	15,0	G1/4	4,8	493478

Drilling template device:

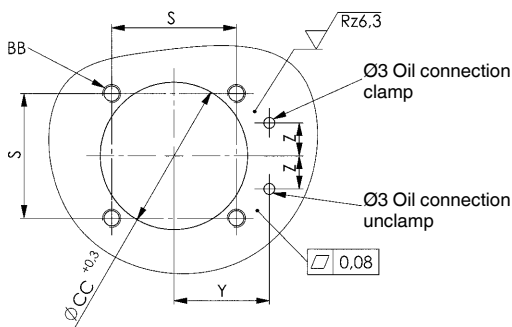

Order no.	Article no.	S	Z	BB	∅CC +0.3	Y
556960	6941KP-03-21	31,4	8,5	M4	36,5	23,5
556961	6941KP-03-22	31,4	8,5	M4	36,5	23,5
556962	6941KP-04-21	34,0	9,0	M5	40,5	26,0
556963	6941KP-04-22	34,0	9,0	M5	40,5	26,0
556964	6941KP-05-21	40,0	11,0	M5	48,5	30,0
556965	6941KP-05-22	40,0	11,0	M5	48,5	30,0
556966	6941KP-09-21	47,0	12,0	M6	55,5	33,5
556967	6941KP-09-22	47,0	12,0	M6	55,5	33,5
556968	6941KP-11-21	55,0	15,0	M6	65,5	39,5
556969	6941KP-11-22	55,0	15,0	M6	65,5	39,5

Subject to technical alterations.

Diagrams:

6941KP-03

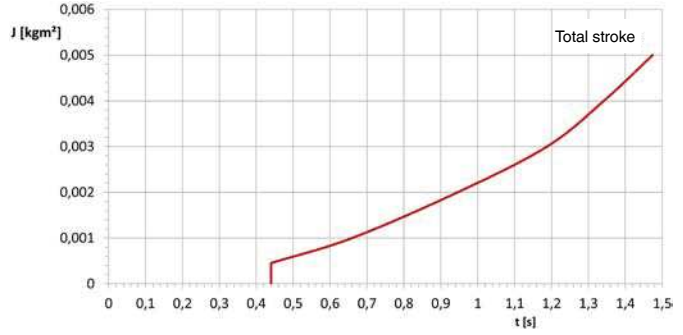
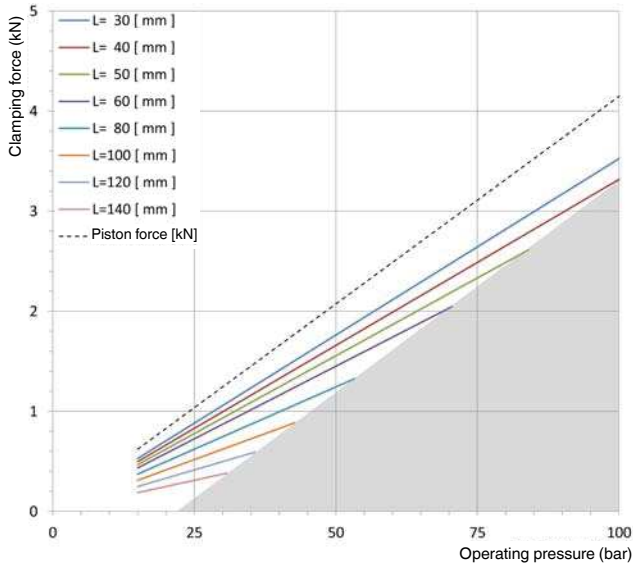

6941KP-04

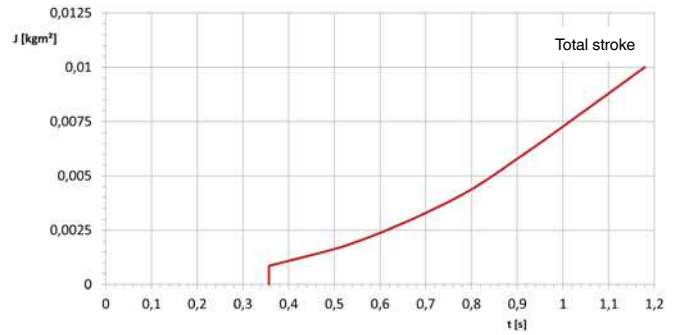
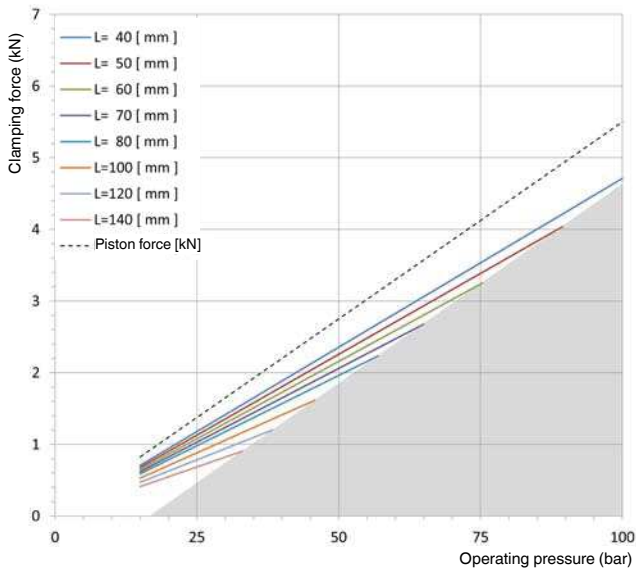

6941KP-05

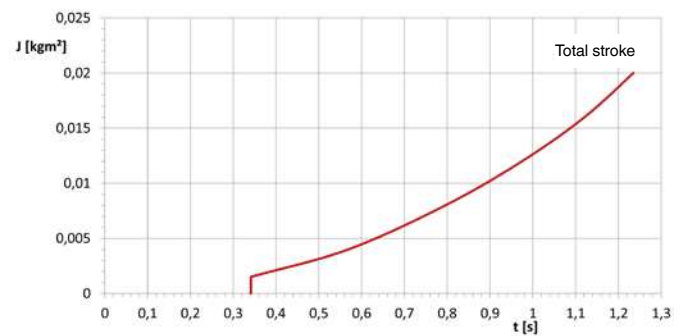
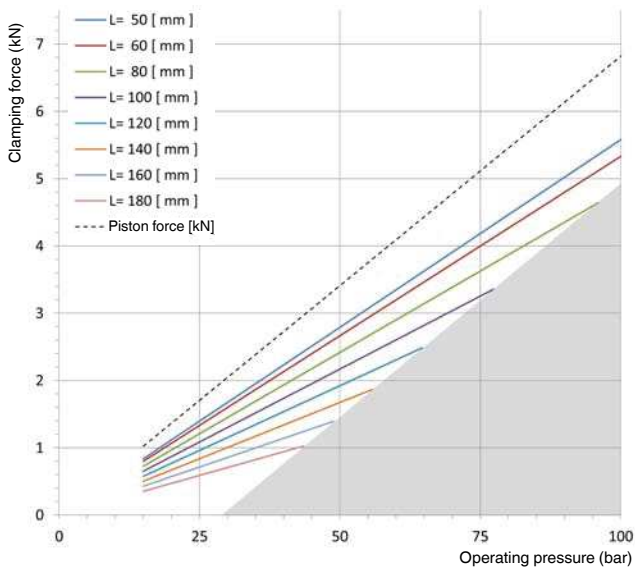

Subject to technical alterations.

6941KP-09

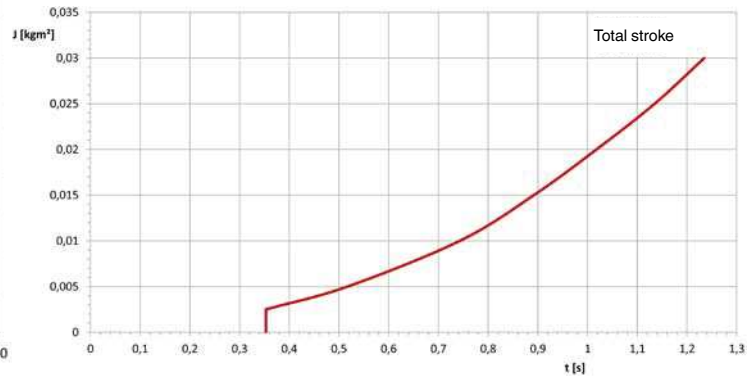
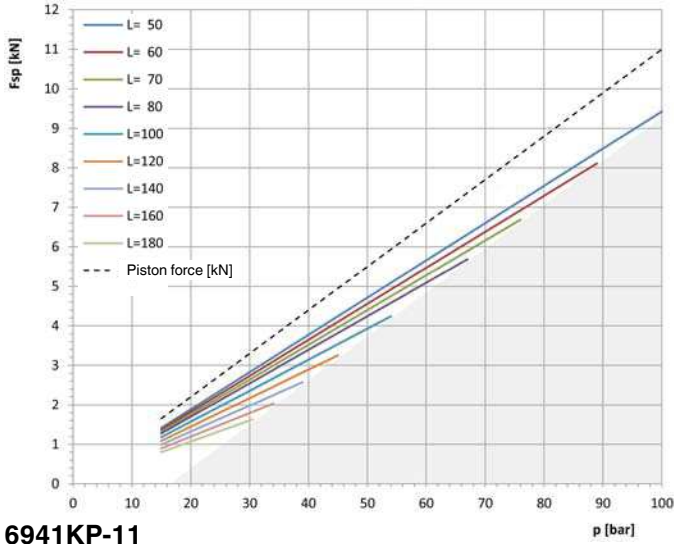

6941KP-11

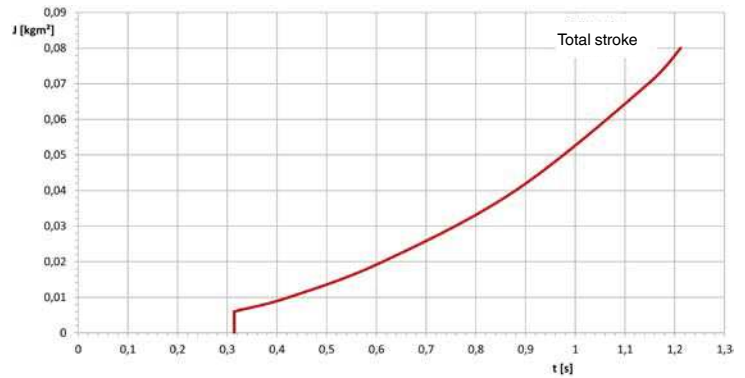
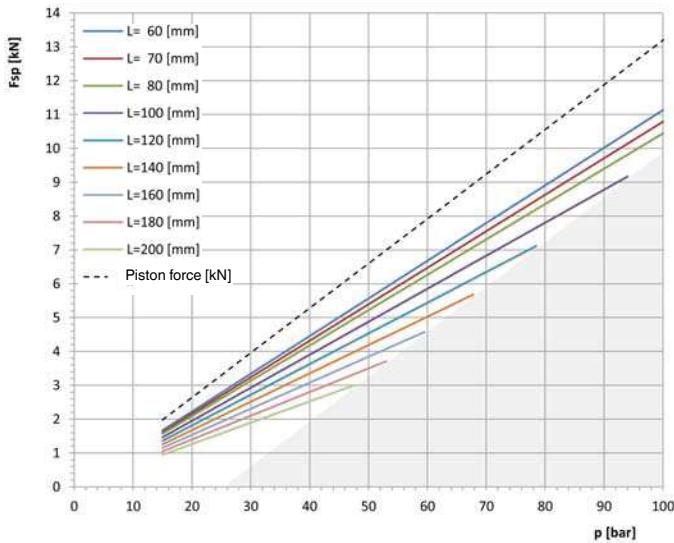

No. 6941

Dimensions for proprietary manufacturing of clamping arms

Important note:

Lever lengths and lever weights must be observed!

Dimensions table (proprietary manufacture):

for size	A	B	ØC	D	ØE	F	G	ØJ	K	M	N	S	ØU	V
6941KP-04	29,0	27,0	18,000 +0,02	22,00	11,0	31,5	8,0	8,5	M8	2,9	43,5	5	15	18,2
6941KP-03	25,5	22,0	15,913 +0,05	18,03	11,0	27,5	8,8	8,5	M8	2,9	38,5	5	15	17,0
6941KP-05	35,0	32,0	22,263 +0,05	25,40	13,5	32,5	12,0	10,5	M10	2,9	46,5	5	18	19,0
6941KP-09	35,0	38,5	25,000 +0,02	30,50	12,5	42,5	11,0	12,5	M12	2,9	52,5	4	18	23,2

Tolerance DIN ISO 2768 m

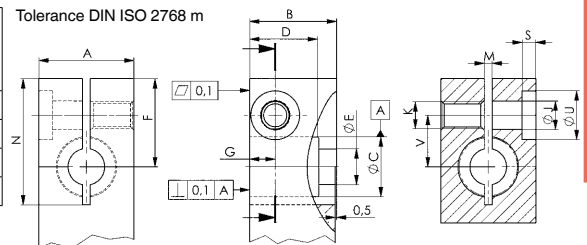

Dimensions table (proprietary manufacture):

for size	A	B	ØC +0,0025	D	E	ØG	H	J	K	T	U	V	W
6941KP-11	51,0	44,5	31,775	37,4	12,5	16,5	M16 x 1,50-6H	59	2,93	22,4	26	6,2	25,7

Tolerance DIN ISO 2768 m

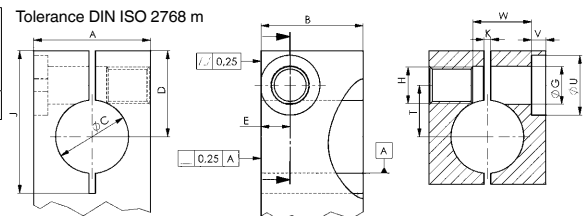

Subject to technical alterations.